

SWIT®

MATRIX- S8/A8/B8
8 channel charger
Ver:A

USER MANUAL

SWIT Electronics Co.,Ltd.

Tel:+86-25-85805753
Fax:+86-25-85805296
<http://www.swit.cc>
E-mail: contact@swit.cc

Thank you for choosing SWIT products. Please read the instructions before using, and keep it for future reference.

Warning

Remember the following precautions to avoid the risk of fire or electric shock!

- Do not allow the charger to come into contact with rain or leave it in a damp place.
- Do not dismantle the charger yourself, and repairs should only be carried out by qualified personnel.
- Do not touch the inside of the charger with metal, conductive objects.
- Do not use any metal objects to short the charging channel terminals.
- Do not connect to a power supply that exceeds the voltage range of the product.

Notice

- Charging is restricted to SWIT batteries only, charging other brands of batteries may be dangerous due to incompatibility.
- Keep the electrodes of the battery and charger clean and ensure reliable contact.
- It is normal for the charger to get warm during charging.
- Do not cover the cooling air ducts.
- Do not place the charger in an unstable place and ensure that the screws are locked as tightly as possible when mounting, this product can be seriously damaged by dropping it.
- Please use the original factory standard AC power cable to avoid damage to the unit.

Product features

- Intelligent recognition of fast-charging and non-fast-charging batteries, the MATRIX-S/A8 can support up to eight simultaneous 6A charges.
- MATRIX-S/B8 automatically recognises SWIT 14.4V and 28.8V batteries and adapts to the charging voltage.
- Real-time monitoring of the current state of the battery and intelligent adjustment of the charging current, making charging more efficient.
- Eight individual LEDs for clear indication of battery charge status.
- Comprehensive temperature, voltage and current protection for safe and reliable use.
- It can be used in a variety of scenarios, including wall-mounted, shelf-mounted and flat.

Appearance

MATRIX-S8

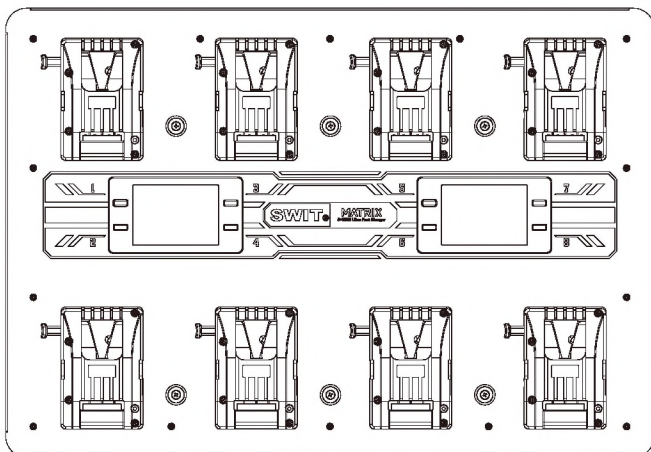

MATRIX-A8

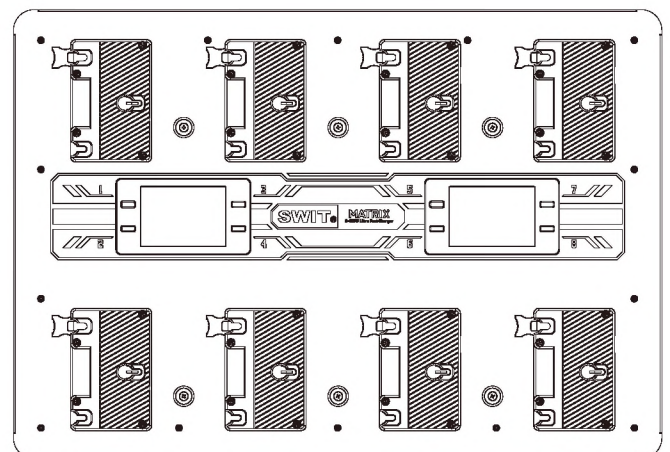

MATRIX-B8

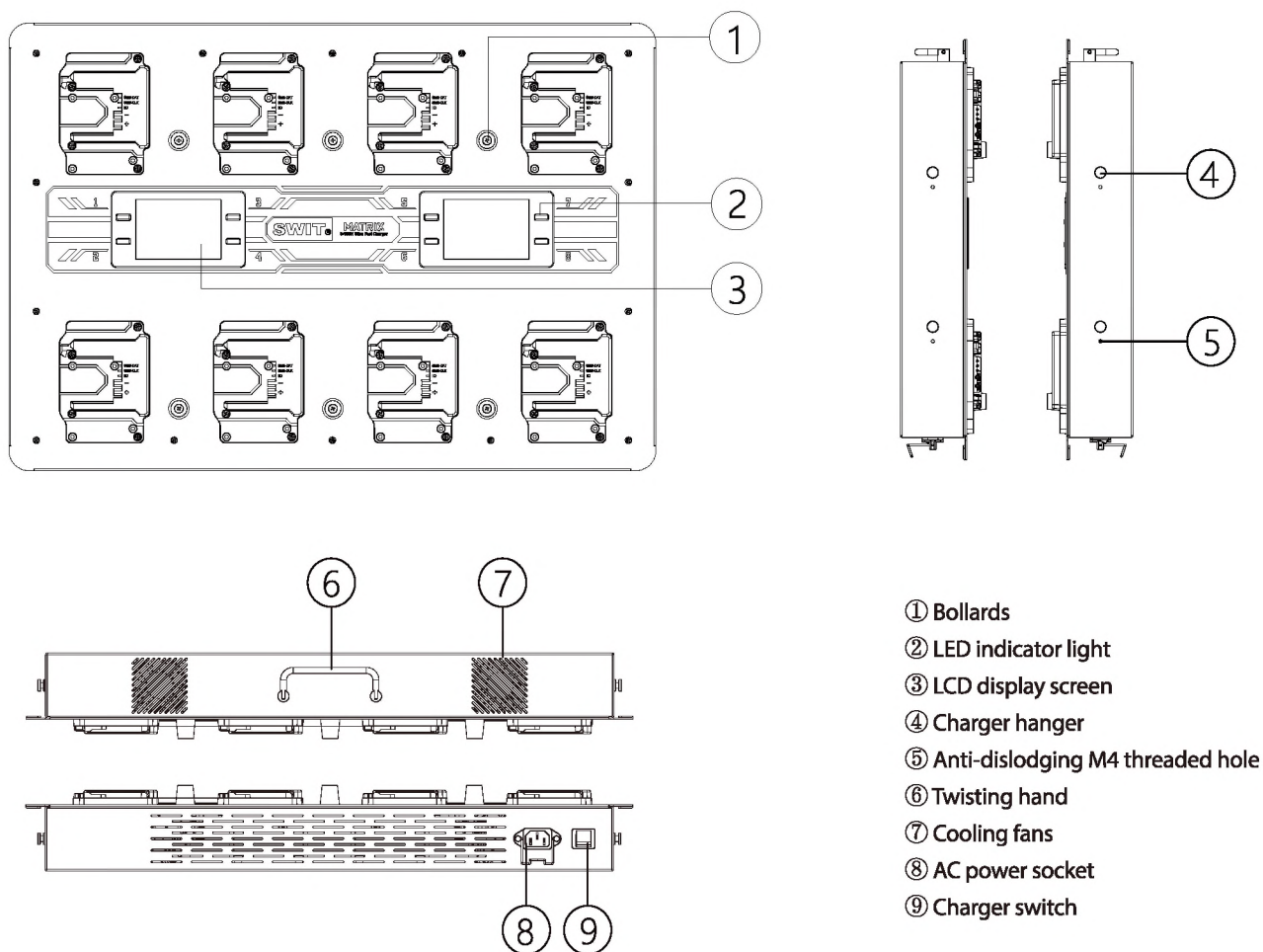

Charging and Display Function

■ Charging status indicator:

0%~80% Red light always on

81%~99% Green light flashing

100% Green light always on

Error: Red light flashing

■ Display:



■ Charging in progress

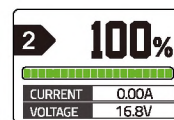
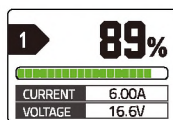
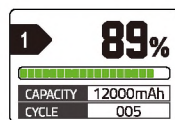

①

②

③

④

① Charger ready to start charging.

② After mounting the battery, it prompts for the battery capacity and the number of cycles, displays 5s and then enters the charging screen ③.

③ Displays battery capacity percentage, charging progress bar, battery voltage and charging current.

④ Charging complete.

3. Relationship between charging current and battery temperature for fast-charging batteries.

MATRIX-S/A8 (16.8V/6A Fast charging)		MATRIX-B8 (33.6V/3A Fast charging)	
Battery temperature	Charging current	Battery temperature	Charging current
<45°C	6A	<48°C	3A
≥45°C	3A, Resume 6A charging after battery temperature drops below 40°C	≥48°C	1.3A, Resume 3A charging after battery temperature drops below 45°C



The battery is protected from charging over temperature and the charger can intelligently identify the battery temperature and restart charging when the battery temperature is reduced.

4. Anomalies

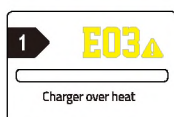

Code of Error :

E01	Battery charge activation failed	Please check the battery status and try to re-mount it.
E02	Communication anomalies	Please reinsert the battery.
E03	Charger overtemperature protection	Please check if the fan is working when the charger is started, if it is, please move the charger to a cool place.
E04	Charger anomalies	Please re-insert the battery; for non-digital batteries, please wait for the battery to return to room temperature before re-inserting.
E05	Self-test failure	Please disconnect the charger and restart it.

Complete machine specifications

Model	MATRIX-S8	MATRIX-A8	MATRIX-B8
Plate	V-Mount	Gold-Mount	B-Mount
Input power	100~240VA,50/60Hz		
Input power	900W(Max)		
Charge output	16.8V= 3A /6A×8 channels; 33.6V= 3A ×8 channels	16.8V=3A/6A×8 channels	16.8V=1.3A/3A×8 channels; 33.6V=1.3A /3A×8 channels
Operating temperature	0°C~40°C		
Operating humidity	10%RH~90%RH		
Size	630×436×89mm		
Net weight	Around 10.6kg		

Installation method

Installation diagram:

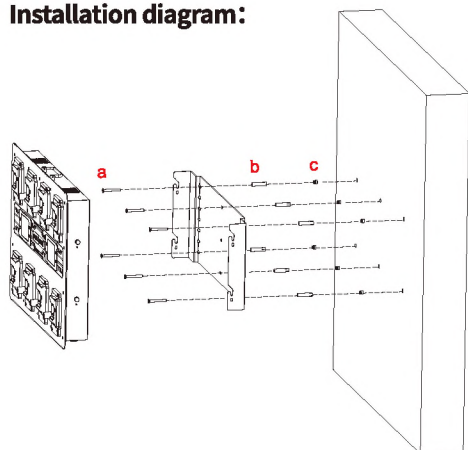

Installation steps:

1. Use the 6 mounting holes in the wall bracket according to the diagram and mark the corresponding positions on the wall with a marker;
2. Drill a hole in the solid wall to the same size as the expansion tube b, approximately 10mm in diameter and 50mm in depth, according to the location markings;
3. Insert the expansion screw a through the bracket, attach the expansion tube b and the header c in turn and turn until half-loose;
4. Place the expansion screw in the hole and tighten it with the hexagonal spanner, the expansion tube b will be hung on the wall after the force is applied;
5. Place the lugs of the 8-channel charger into the recesses on either side of the hanger to complete the installation.

Note: If mounting this charger on a stand, take care to keep a distance of 10cm or more between the top and bottom chargers.